

SDPD16007020

piatto doccia/ shower tray

codice  
code

Piatto doccia SoloDue H2 cm 160 X 70.  
SoloDue h2 cm 160 X 70 shower tray.



cotone/ cotton

SDPD16007020CT

finiture COLORS 1250°/ COLORS 1250° finishing

SDPD16007020...

(Specificare il colore al momento dell'ordine/ Specify the color when ordering)

SDPD16007020 CT/CE/CA...

finiture Le malteceramiche / Le malteceramiche finishing

SDPD16007020...

(Specificare il colore al momento dell'ordine/ Specify the color when ordering)

SDPD16007020 MC/MB....

finiture SHINE/ SHINE finishing

SDPD16007020...

(Specificare il colore al momento dell'ordine/ Specify the color when ordering)

SDPD16007020 PS/SA/SS

cm 160x70xh2

scatole/box 1

kg 37

Tecnologie/technologies:

Spessore di 2 cm  
2 cm thickness

Taglio su misura  
Bespoke cut

Trattamento Antiscivolo  
Anti-slip

Piletta di scarico  
Waste system

Antibatterico  
Antibacterial

Dimensione minima 60cm  
minimum size 60cm

Dimensione massima 200cm  
maximum size 200cm

Taglio verticale, diagonale, bespoke  
Vertical, diagonal and bespoke cut

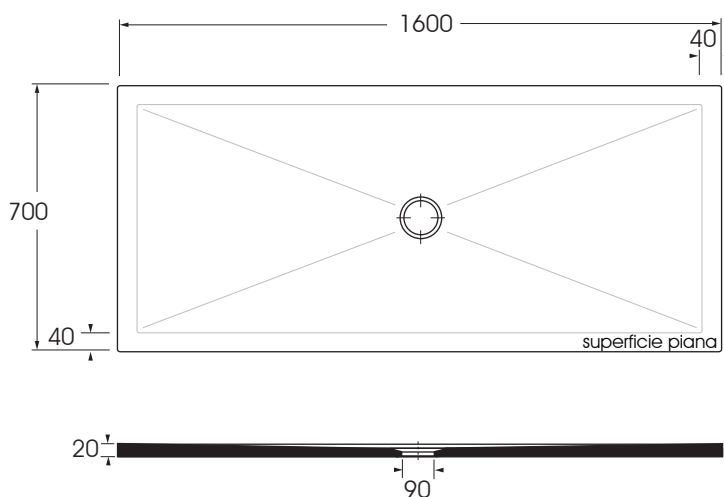

scala/scale 1:20 dimensioni/dimensions in mm

- Colori disponibili per tutti i prodotti SOLODUE  
e per il tappo copripiletta

COLORS 1250°

- Available for all SOLODUE products  
and for the free flow drains



Le malteceramiche

SHINE



Complementi/complements:

Codice  
code



Piletta doccia cromo in PET riciclato 1" 1/4 di diametro ø 90 con tappo serigrafato completa di curva terminale  
Chrome recycled PET shower drain 1" 1/4 diameter ø 90 with screen-printed cap complete with end bend

SIF/H2

kg 0,5

Per le varianti colore in PET riciclato specificare il codice colore al momento dell'ordine  
For recycled PET color variants please specify the color code when ordering

TECHNICAL SHEET n°: <b>01</b>	DESIGNER: <b>OFFICINA AZZURRA</b>	CODE: <b>SDPD16007020</b>	Azzurra sanitari in ceramica S.p.a. via Civita Castellana snc 01030 Castel S.Elia (VT) - ITALY Tel.+39.0761 518155 Fax.+39.0761 514560	
SHEET FORMAT: <b>A4</b>	ISO	REVISION: <b>04</b>	SCALE: <b>1:20</b>	DATE: <b>12/03/2025</b>
REGULATIONS: <b>CE EN 14527 / EN251 / Dop-14527*</b>				
All the measurements respect the tolerances provided by the "AZZURRA QUALITY GUIDELINES".				



\* Regulations here shown are exclusively referred to ceramic items