

SDPD13007020

piatto doccia/ shower tray

codice
code

Piatto doccia SoloDue H2 cm 130 X 70.
SoloDue h2 cm 130 X 70 shower tray.



cotone/ cotton

SDPD13007020CT

finiture COLORS 1250°/ COLORS 1250° finishing

SDPD13007020...

(Specificare il colore al momento dell'ordine/ Specify the color when ordering)

SDPD13007020 CT/CE/CA...

finiture Le malteceramiche / Le malteceramiche finishing

SDPD13007020...

(Specificare il colore al momento dell'ordine/ Specify the color when ordering)

SDPD13007020 MC/MB....

finiture SHINE/ SHINE finishing

SDPD13007020...

(Specificare il colore al momento dell'ordine/ Specify the color when ordering)

SDPD13007020 PS/SA/SS

cm 130x70xh2

scatole/box 1

kg 33

Tecnologie/technologies:

Spessore di 2 cm
2 cm thickness

Taglio su misura
Bespoke cut

Trattamento Antiscivolo
Anti-slip

Piletta di scarico
Waste system

Antibatterico
Antibacterial

Dimensione minima 60cm
minimum size 60cm

Dimensione massima 200cm
maximum size 200cm

Taglio verticale, diagonale, bespoke
Vertical, diagonal and bespoke cut

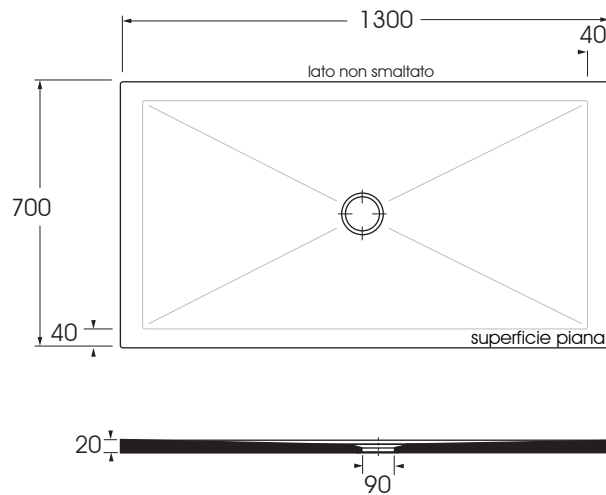

scala/scale 1:20 dimensioni/dimensions in mm

- Colori disponibili per tutti i prodotti SOLODUE
e per il tappo copripiletta

COLORS 1250°



- Available for all SOLODUE products
and for the free flow drains

Le malteceramiche



SHINE



Complementi/complements:

Codice
code



Piletta doccia cromo in PET riciclato 1" 1/4 di diametro ø 90 con tappo serigrafato completa di curva terminale
Chrome recycled PET shower drain 1" 1/4 diameter ø 90 with screen-printed cap complete with end bend

SIF/H2

kg 0,5

Per le varianti colore in PET riciclato specificare il codice colore al momento dell'ordine
For recycled PET color variants please specify the color code when ordering

TECHNICAL SHEET n°: 01	DESIGNER: OFFICINA AZZURRA	CODE: SDPD13007020	Azzurra sanitari in ceramica S.p.a. via Civita Castellana snc 01030 Castel S.Elia (VT) - ITALY Tel.+39.0761 518155 Fax.+39.0761 514560	
SHEET FORMAT: A4	ISO	REVISION: 04	SCALE: 1:20	DATE: 12/03/2025
REGULATIONS: CE EN 14527 / EN251 / Dop-14527*				
All the measurements respect the tolerances provided by the "AZZURRA QUALITY GUIDELINES".				



* Regulations here shown are exclusively referred to ceramic items